

# CC2652R / CC2652RB

(zzh boards ship with CC2652R)

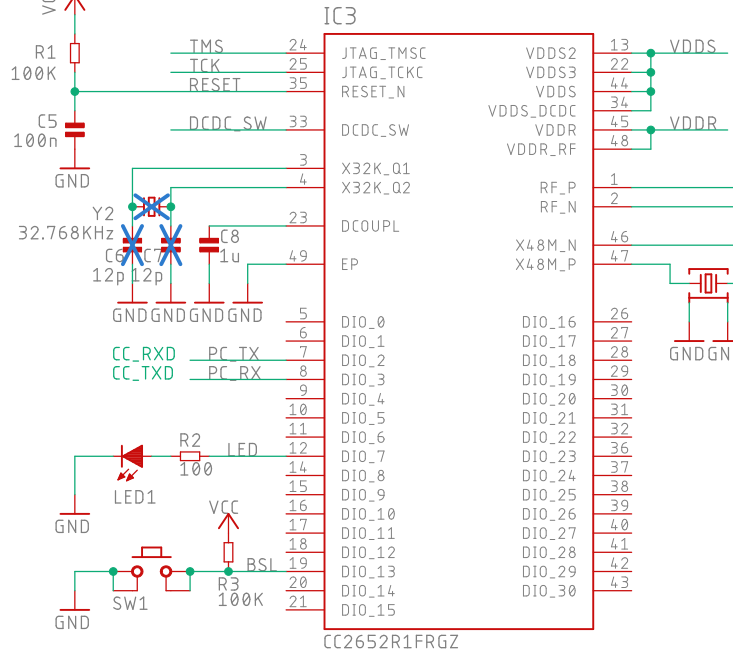

BSL Trigger button and general purpose LED

## Balun & Pi Filter

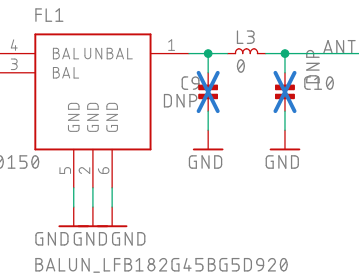

## Edge Mount Female SMA

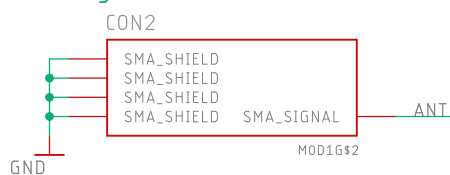

## cJTAG Debug

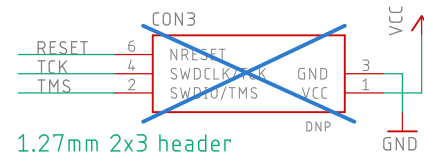

1.27mm 2x3 header  
Use zzh-debug adapter PCB to convert to standard 2x5 pinout.

## VDD5 Decoupling

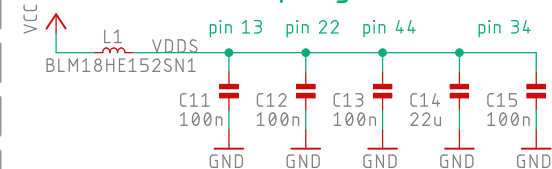

## VDD8 Decoupling

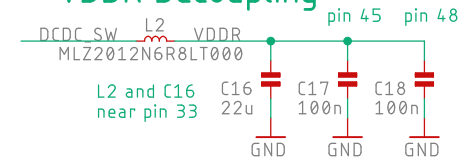

## 3V3 LDO

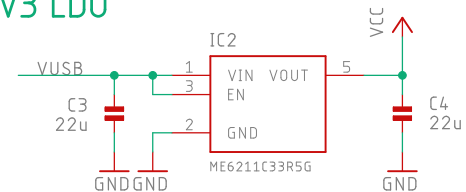

## USB Serial

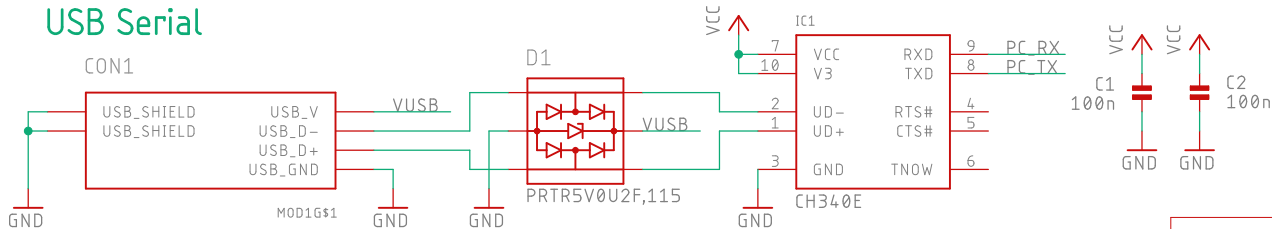

## Reference Designs:

<http://www.ti.com/tool/LAUNCHXL-CC26X2R1>  
<http://www.ti.com/tool/TIDA-010012>



zig-a-zig-ah!  
<http://electrolama.com/p/zzh>  
Licensed under the Solderpad  
Hardware License 2.0.

Revision A

zzh  
10/05/2020 13:59

Sheet: 1/1